

Intermediate layer 120 mm (Z 120)

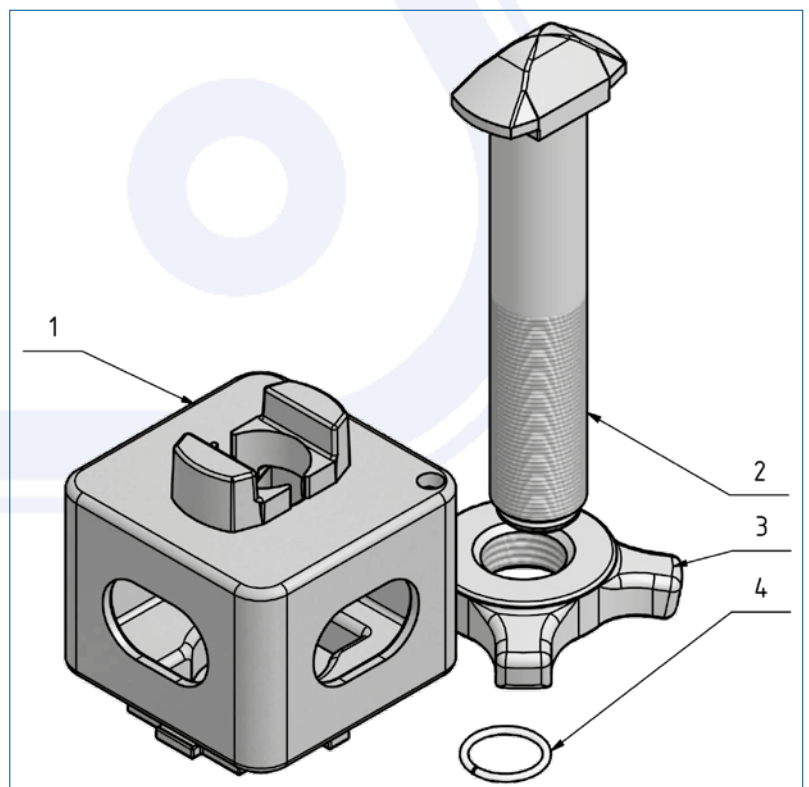

- > steel galvanized
- > to adjust height of gooseneck chassis
- > in conjunction with the lock 905.165.000
- > all inner parts are galvanized and not installed
- > weight 15 kg

Art.-No. 905.167.500

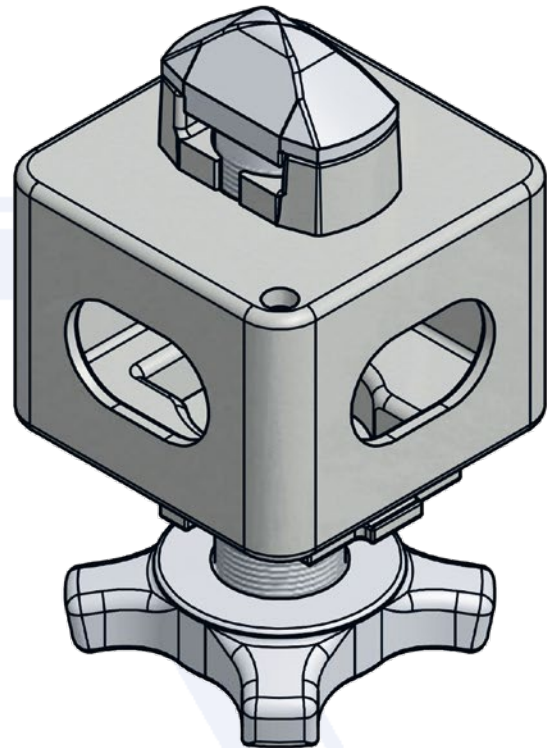
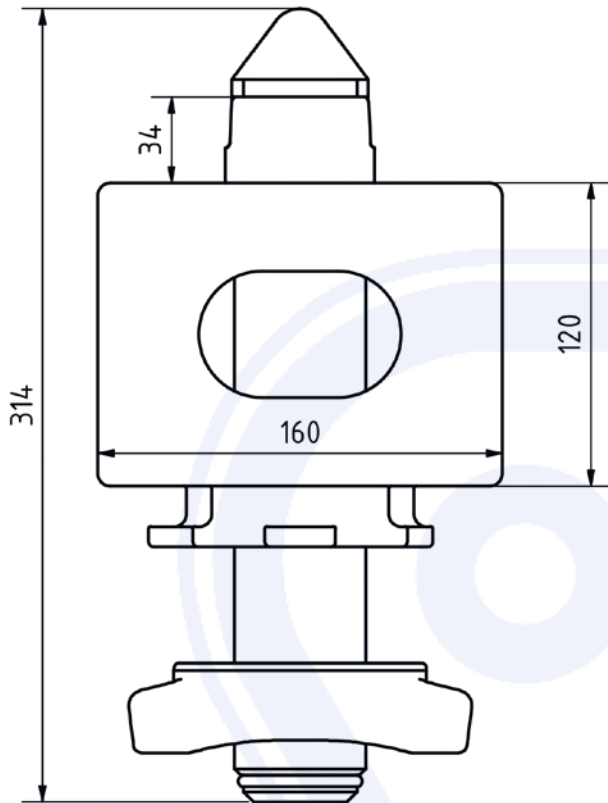

Pos.	Spare part	Art.-No.
1	Intermediate layer 120 mm	905.167.202
2	Locking pin	905.000.313
3	Locking nut	905.000.088
4	Security ring	905.000.187